

High Accuracy Pressure Sensor



Features

- ➔ Available with Built in Electronic
- ➔ Large choice of connectors & threads
- ➔ All Stainless steel
- ➔ Large Bandwidth

Applications

- ➔ Railway
- ➔ Test benches
- ➔ Instrumentation
- ➔ Navy and shipbuilding applications

The PTA220 series is designed for absolute or gage pressure measurements from 50mbar up to 600bar. With all stainless steel wetted parts, it is compatible with most fluids used in the industry including corrosive ones. Manufactured with proven components ensuring accuracy and reliability, the PTA220 is compatible with most application thanks to a large choice of mechanical and electrical connections

Technical specifications

Pressure ranges (FS)	<p>±100mbar ; ±250mbar ; ±500mbar ;</p> <p>250mbar ; 700/1200mbar ; 500mbar ;</p> <p>±1bar ; -1/+2bar ; -1/+3bar ; -1/+5bar ; -1/+10bar ;</p> <p>1bar ; 2bar ; 3bar ; 5bar ; 10bar ; 20bar ; 40bar ; 100bar ; 250bar ; 400bar ; 600bar ;</p> <p>±14.5PSI ; -14.5/+30PSI ; -14.5/+40PSI ; -14.5/+70PSI ; -14.5/+150PSI ;</p> <p>8000PSI ; 3PSI ; 5PSI ; 10PSI ; 15PSI ; 30PSI ; 40PSI ; 70PSI ; 150PSI ; 300PSI ; 500PSI ;</p> <p>1500PSI ; 3000PSI ; 10000PSI ; 5000PSI</p>
Type	Absolute ; Gage
Type (for ranges > 40 bar)	Sealed Gage
Safe overload	<p>150% FS</p> <p>Option : Special overload</p>
Burst pressure	300% FS
Power supply	15 to 30Vdc
Consumption	< 10mA
Insulation	> 1000 MOhms under 50Vdc at ambient temperature

Technical Specifications

Output at -100%FS (only for \pm range)	0Vdc
Output at 0%FS (except ranges \pm)	0Vdc
Output at 100%FS	10Vdc
Zero and sensitivity settings tolerances	$\pm 50\text{mV}$
Non linearity and hysteresis combined	$\pm 0.1\%$ FS Option : $\pm 0.05\%$ FS
Non repeatability	$\pm 0.02\%$ FS typ.
Signal bandwidth	1000Hz @ -3dB
Compensated temperature range	0 to $+60^\circ\text{C}$ Option : -25 to $+85^\circ\text{C}$; -25 to $+125^\circ\text{C}$ (Except M12, 723 Receptacles and PVC Cable)
Operating temperature range	-25 to $+125^\circ\text{C}$ (-25 to $+90^\circ\text{C}$ with M12, 723 Receptacles and PVC Cable)
Combined thermal zero & sensitivity shifts	$\pm 0.02\%$ FS/ $^\circ\text{C}$
Constant acceleration in linear vibrations	$\pm 0.02\%$ FS/g (frequency 20-2000Hz, 50g max.)
Mechanical shock	100g $\frac{1}{2}$ sinus 1ms
Electrical protection	Protected against polarity inversion
EMC protection	Compliant to EN61000
Electrical connection	DIN 43650 Receptacle - 4 pins Option : Miniature DIN 43650 mPm Receptacle - 4 pins ; Receptacle M12 - 4 pins ; Hermetic MIL-C-26482 - 6 pins Receptacle ; AWG26, Viton Jacketed Shielded Cable $\varnothing 3\text{mm}$, 4 wires ; AWG24 double Shield PVC Cable, 4 wires ; Hermetic M12 4 pins Receptacle ; Binder 723 Receptacle, 5 pins
Mechanical connection	$\frac{1}{4}$ Gaz A male ; $\frac{1}{4}$ NPT male Option : $\frac{1}{2}$ Gaz A male (Gauge) ; $\frac{1}{4}$ Gaz female ; 7/16-20 UNJF-3A male - MS33656-4 ; M10x1-4h male with 80° internal cone ; M10x1-4h male 120° cone ; M14x1.5-4h male
Material(s) of wetted parts	Stainless Steel 316L ; Stainless Steel 17-4PH ; Stainless steel 15-5PH
Weight	< 100g without cable
Enclosure protection	IP65 for absolute & sealed gage version

Codification

High Accuracy Pressure Sensor	PTA22	6	S	10bar	A	01	01	A	2	1	L
Output Signal											
	0-10Vdc		6								
Material											
	Stainless Steels		S								
Range											
	Example			10bar							
Type											
	Absolute				A						
	Gage				G						
	Sealed Gage				SG						
Mechanical connection											
	M14x1.5-4h male					01					
	1/2 Gaz A male (Gauge)					06					
	1/4 Gaz A male					07					
	1/4 Gaz female					08					
	7/16-20 UNJF-3A male - MS33656-4					10					
	1/4 NPT male					13					
	M10x1-4h male with 80° internal cone					19					
	M10x1-4h male 120° cone					21					
Electrical connection											
	DIN 43650 Receptacle - 4 pins						01				
	Miniature DIN 43650 mPm Receptacle - 4 pins						02				
	Hermetic MIL-C-26482 - 6 pins Receptacle						03				
	Receptacle M12 - 4 pins						07				
	AWG26, Viton Jacketed Shielded Cable Ø3mm, 4 wires						08/1m				
	AWG24 double Shield PVC Cable, 4 wires						10/1m				
	Hermetic M12 4 pins Receptacle						15				
	Binder 723 Receptacle, 5 pins						23				
Compensated temperature range											
	0 to +60°C							A			
	-25 to +85°C							B			
	-25 to +125°C (Except M12, 723 Receptacles and PVC Cable)							C			
Non linearity and hysteresis combined											
	±0.1% FS								2		
	±0.05% FS								4		
Combined thermal zero & sensitivity shifts											
	±0.02% FS/°C									1	
Options											
	Special overload										L



Presented by: Absolute Gauge Technologies
 sales@absolute-gauge.com; www.absolute-gauge.com,
 Toronto: 416 754 3168, Montreal: 514 695 5147, Toll Free: 1 888 754 7008

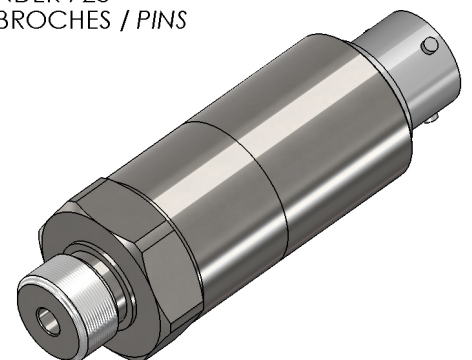
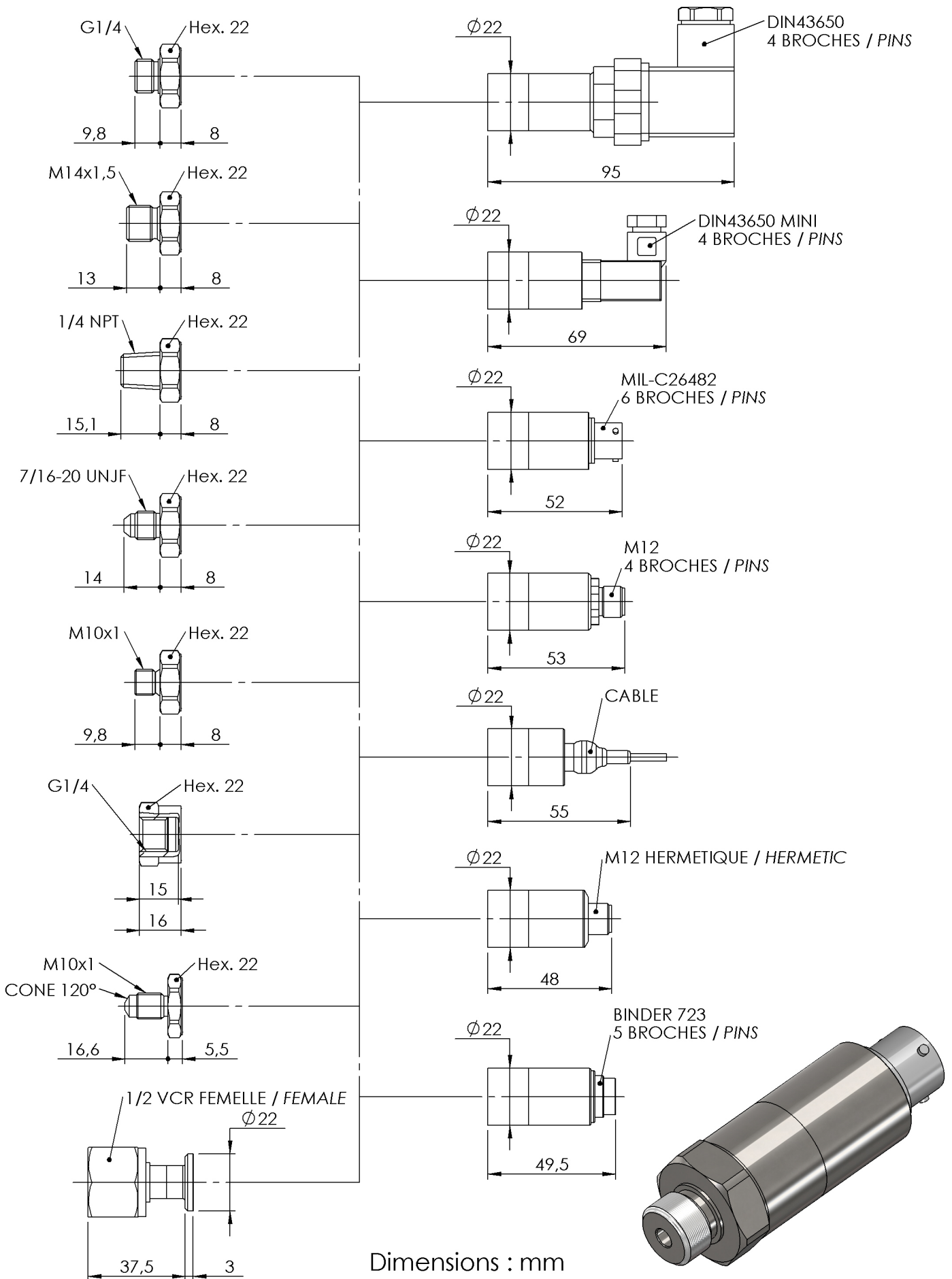

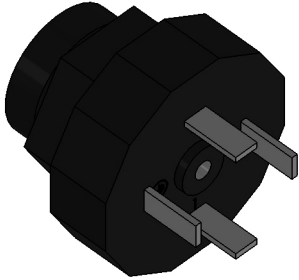

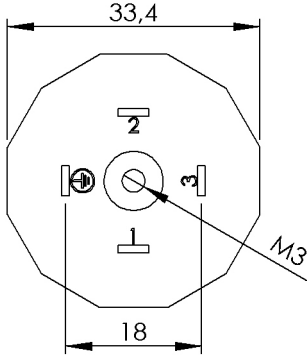

DIN 43650 - 4 PINS	
VOLTAGE OUTPUT	PIN
+ EXCITATION	PIN 1
+ SIGNAL	PIN 2
0 VOLT	PIN 3
SENSOR HOUSING	PIN T



Dimensions : mm

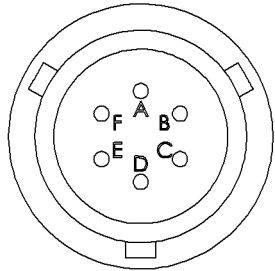

MIL-C26482 - 6 PINS	
VOLTAGE OUTPUT	PIN
+ EXCITATION	PIN A
+ SIGNAL	PIN B
0 VOLT	PIN C
0 VOLT	PIN D
SENSOR HOUSING	PINS E & F

#26 AWG, 4 CONDUCTOR SHIELDED VITON CABLE	
VOLTAGE OUTPUT	CONDUCTOR
+ EXCITATION	RED
+ SIGNAL	GREEN / YELLOW
NC	WHITE
0 VOLT	BLUE / BLACK
SENSOR HOUSING	SHIELD



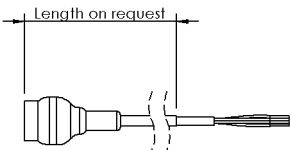
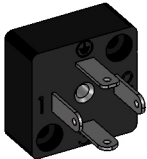

DIN MINIATURE 43650 - 4 PINS	
VOLTAGE OUTPUT	PIN
+ EXCITATION	PIN 1
+ SIGNAL	PIN 2
0 VOLT	PIN 3
SENSOR HOUSING	PIN T

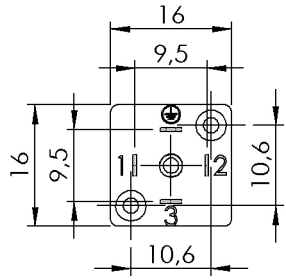

Dimensions : mm

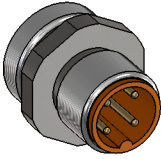



M12 - 4 PINS	
VOLTAGE OUTPUT	PIN
+ EXCITATION	PIN 1
+ SIGNAL	PIN 4
NC	PIN 2
0 VOLT	PIN 3
SENSOR HOUSING	CONNECTOR HOUSING

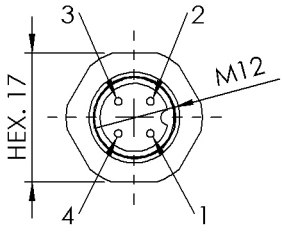

Dimensions : mm

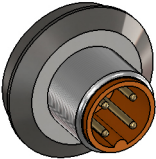

HERMETIC M12 - 4 PINS	
VOLTAGE OUTPUT	PIN
+ EXCITATION	PIN 1
+ SIGNAL	PIN 4
NC	PIN 2
0 VOLT	PIN 3
SENSOR HOUSING	CONNECTOR HOUSING

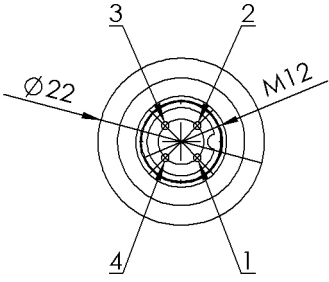

Dimensions : mm



BINDER 723 - 5 PINS	
VOLTAGE OUTPUT	PIN
+ EXCITATION	PIN 3
+ SIGNAL	PIN 2
NC	PIN 4
0 VOLT	PIN 1
NC	PIN 5
SENSOR HOUSING	CONNECTOR HOUSING

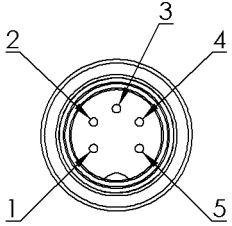

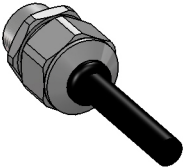

#24 AWG, 4 CONDUCTOR, DOUBLE SHIELD PVC CABLE	
VOLTAGE OUTPUT	CONDUCTOR
+ EXCITATION	RED
+ SIGNAL	GREEN
0 VOLT	WHITE
NC	BLACK
SENSOR HOUSING	SHIELD

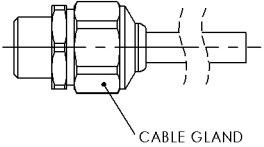

CABLE GLAND



Presented by: Absolute Gauge Technologies
sales@absolutegauge.com;
www.absolutegauge.com,
Toronto: 416 754 3168, Montreal: 514 695 5147,
Toll Free: 1 888 754 7008