

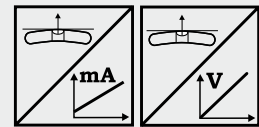

**Analog Inclination Sensor with 1 axis or 2 axes in MEMS technology**

- Measurement range ±180° with 1 axis or 2 axes
- Protection class IP67
- Linear analog output
- Plastic housing
- Wear free, high resolution
- High shock resistance



<b>Specifications</b>	Output /Excitation	U2	Voltage 0.5 ... 10 V / $U_B = 18 ... 36$ V
		U6	Voltage 0.5 ... 4.5 V / $U_B = 5$ V DC ±5%
		U8	Voltage 0.5 ... 4.5 V / $U_B = 10 ... 36$ V
		I1	Current 4 ... 20 mA / $U_B = 18 ... 36$ V, 10 ... 36 V
	Measurement range		±15 ... ±180° with 1 axe or 2 axes
	Resolution		0.1°
	Linearity		1 axis : ±0.5° (≤75°), ±1° (>75°) 2 axes : ±1° (≤75°), ±1.5° (>75°)
	Settling time		0.1 ... 10 s / 90 %, configurable
	Protection class		IP67
	Material		Plastic
Connection		Cable 5 x 0.25 mm <sup>2</sup>	
Shock (non-operational)		EN60068-2-27:1993, 100 g/11 ms, 100 shocks	
Vibration (non-operational)		EN60068-2-6:1995, 20 g/10 Hz-2 kHz, 10 cycles	
EMC, temperature		Refer to output specification	

**Order code PTAM27**



**Model name**

**Number of axes**

- 1 = Inclination in X axis (mounting X)
- 2 = Inclination in X and Y axes (mounting XY)

**Measurement range [in °]**

15 ... 180 = ±15°... ±180° in 15° increments

**Output**

- U2 = 0.5 ... 10 V
- U6 = 0.5 ... 4.5 V
- U8 = 0.5 ... 4.5 V
- I1 = 4 ... 20 mA

**Characteristic**

- CW = Increasing signal for CW inclination
- CCW = Increasing signal for CCW inclination

**Output delay 0 ... 90 %**

Tx.x = 0.1 s ... 10 s

**Connection**

KAB2M = Cable, standard length 2 m

**Order example: PTAM27 - 1 - 90 - U6 - CCW - T1.0 - KAB2M**



**Digital Inclination Sensor with 1 axis or 2 axes in MEMS technology**

- Measurement range ±180° with 1 axis or ±60° with 2 axes
- Protection class IP67
- CANopen output
- Plastic housing
- Wear free, high resolution
- High shock resistance

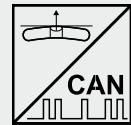

Specifications		
	Output	CANopen (profile „Inclination Sensor“)
	Measurement range	±180° with 1 axis or ±60° with 2 axes
	Resolution	0.05 °
	Linearity	±0.5°
	Settling time	0.1 s ... 10 s / 90%, configurable
	Protection class	IP67
	Material	Plastic
	Connection	5 pin connector M12 with cable, fixed length 0.3 m
	Shock (non-operational)	EN60068-2-27:1993, 100 g/11 ms, 100 shocks
	Vibration (non-operational)	EN60068-2-6:1995, 20 g/10 Hz-2 kHz, 10 cycles
	EMC, temperature	Refer to output specification

**Order code PTDM27**

**Model name**

**Output**

CANOP = CANopen

CANJ1939 = CAN SAE J1939

**Connection**

KAB0.3M-M12/CAN = Cable (length 0.3 m) with connector M12, 5 pin

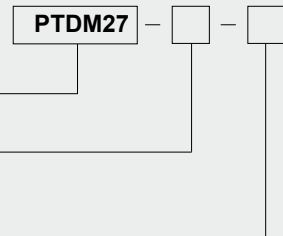

Order code connector cable (see accessoires page 91 )

**KAB - XM - M12/5F/G - M12/5M/G - CAN**

**Order example: PTDM27 - CANOP - KAB0,3M-M12/CAN**

**POSITILT®**  
**PTAM27/PTDM27**  
**Dimensions**



**Outline drawing**  
**PTAM27/PTDM27**

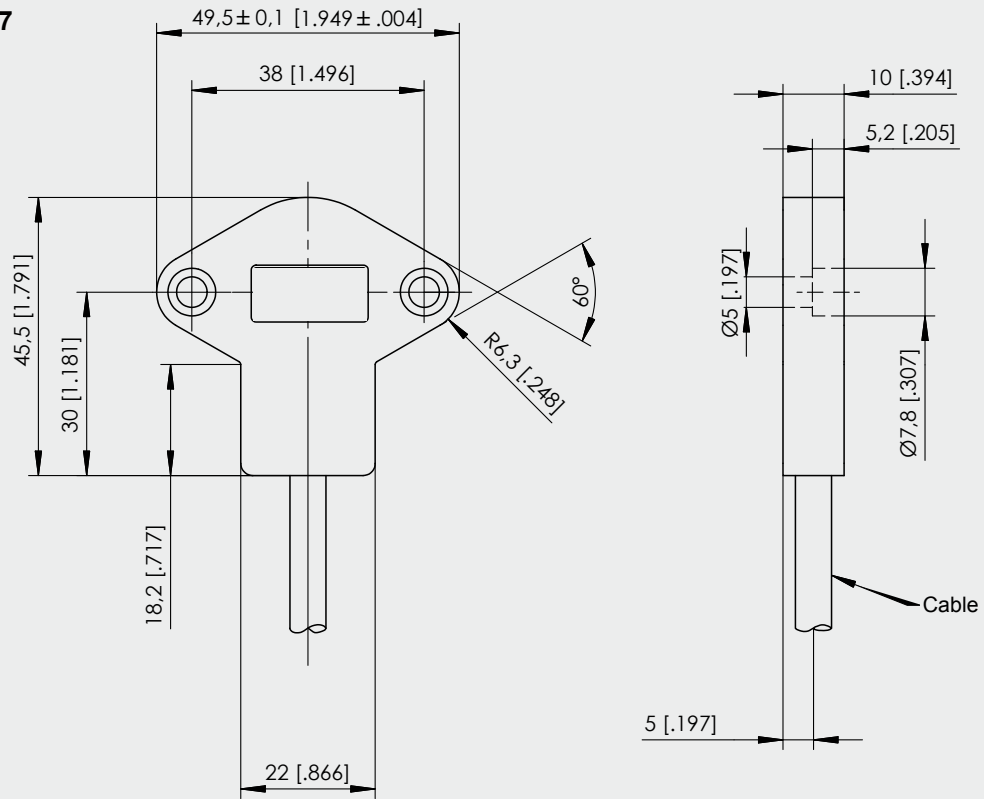

Dimensions in mm [inch]

Dimensions informative only.  
 For guaranteed dimensions consult factory.

**POSITILT®**  
**PTAM27/PTDM27**  
**Dimensions**



Orientation of the  
inclination axes

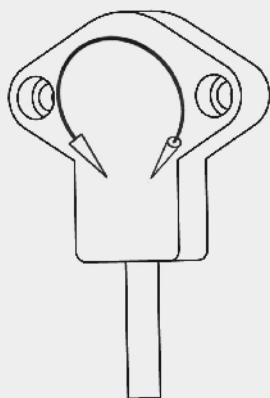

1 axis

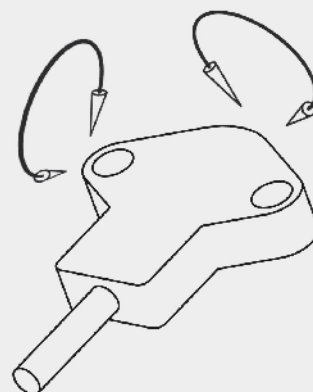

2 axes

<p><b>U2</b> Voltage Output 0.5 ... 10 V</p>	Excitation voltage	18 ... 36 V DC
	Excitation current	12 mA typ., 16 mA max.
	Output voltage	0.5 ... 10 V DC
	Output current	2 mA max.
	Measuring rate	1 kHz standard
	Stability (temperature)	$\pm 100 \times 10^{-6} / ^\circ\text{C}$ f.s. (typ.)
	Operating temperature	-40 ... +85 °C
	Protection EMC	Reverse polarity, short circuit EN61326-1:2006
<p><b>U6</b> Voltage Output 0.5 ... 4.5 V DC</p>	Excitation voltage	5V DC $\pm 10\%$
	Excitation current	16 mA typ., 20 mA max.
	Output voltage	0.5 ... 4.5 V DC
	Output current	2 mA max.
	Measuring rate	1 kHz standard
	Stability (temperature)	$\pm 100 \times 10^{-6} / ^\circ\text{C}$ f.s. (typ.)
	Operating temperature	-40 ... +85 °C
	Protection EMC	Reverse polarity, short circuit EN61326-1:2006
<p><b>U8</b> Voltage output 0.5 ... 4.5 V</p>	Excitation voltage	10 ... 36 V DC
	Excitation current	12 mA typ., 16 mA max.
	Output voltage	0.5 ... 4.5 V DC
	Output current	2 mA max.
	Measuring rate	1 kHz standard
	Stability (temperature)	$\pm 100 \times 10^{-6} / ^\circ\text{C}$ f.s. (typ.)
	Operating temperature	-40 ... +85 °C
	Protection EMC	Reverse polarity, short circuit EN61326-1:2006
<p><b>I1</b> Current Output 4 ... 20 mA</p>	Excitation voltage	18 ... 36 V DC; 10 ... 36 V for R<250Ω
	Excitation current	32 mA typ., 36 mA max..
	Load resistor	500 Ω max.
	Output current	4 ... 20 mA
	Measuring rate	1 kHz standard
	Stability (temperature)	$\pm 100 \times 10^{-6} / ^\circ\text{C}$ f.s. (typ.)
	Operating temperature	-40 ... +85 °C
	Protection EMC	Reverse polarity, short circuit EN61326-1:2006

Other outputs available on request.

**Output signals**

**Connection**

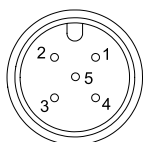

M12A5 / M12R5

View to sensor connector

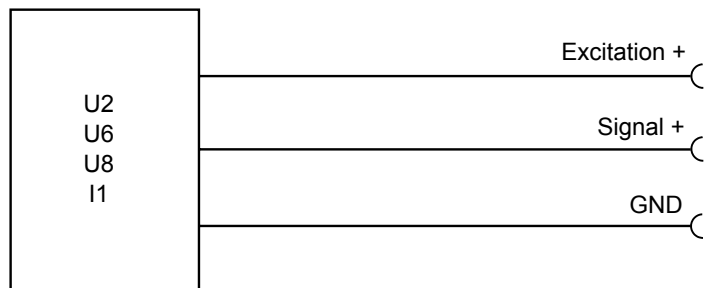

Signal Wiring	Output signals	Connector pin	Cable color
	Excitation +	1	brown
	Output X	2	white
	GND	3	blue
	Output Y	4	black
	Do not connect!	5	gray

# POSITILT<sup>®</sup> PTDM Output CANopen



**Description**                      Inclination sensor with CANopen interface according to CiA 410.

<b>CANopen Interface</b> 	Communication profile	CANopen CiA 301 V 4.02, Slave
	Device profile	Encoder CiA 410 V 1.2
	Configuration services	LSS, CiA Draft Standard 305 (transmission rate, node ID)
	Error Control	Node Guarding, Heartbeat, Emergency Message
	Node ID	Adjustable via LSS or via object dictionary, default: 127
	PDO	1 TxPDO, 0 RxPDO, static mapping
	PDO Modes	Event-/Time triggered, Remote-request, Sync cyclic/acyclic
	SDO	1 Server, 0 Client
	Certified	Yes
	Transmission rate	50 kBaud to 1 MBaud, adjustable via LSS or via object dictionary, default: 125 kBaud
	Bus connection	M12 connector, 5 pin
	Integrated bus terminating resistor	Optional
	Bus, galvanic isolation	No

<b>Specifications</b>	Excitation voltage	8 ... 36 V DC
	Excitation current	15/30 mA typical for 24/12 V, 100 mA max.
	Measuring rate	1 kHz standard
	Stability (temperature)	$\pm 100 \times 10^{-6} / ^\circ\text{C}$ f.s.
	Repeatability	1 LSB
	Operating temperature	-40 ... +85 °C
	Protection	Reverse polarity, short circuit
	EMC	EN61326-1:2006

# POSITILT<sup>®</sup> PTDM Output CAN SAE J1939



**Description** Inclination sensor according to standard SAE J1939. Configuration of operating parameters by proprietary-A-Message (peer-to-peer connection). Process data exchange by proprietary-B-Message (broadcast).

<b>Interface J1939</b> 	CAN specification	ISO 11898, Basic and Full CAN 2.0 B
	Transceiver	24V-compliant, not isolated
	Communication profile	SAE J1939
	Baud rate	250 kbit/s
	Internal termination resistor	120 Ω
	Address	Default 247d, configurable

<b>NAME Fields</b>	Arbitrary address capable	1	Yes
	Industry group	0	Global
	Vehicle system	7Fh (127d)	Non specific
	Vehicle system instance	0	
	Function	FFh (255d)	Non specific
	Function instance	0	
	ECU instance	0	
	Manufacturer	145h (325d)	Manufacturer ID
	Identity number	0nnn	Serial number 21 bit

<b>Parameter Group Numbers (PGN)</b>	Configuration data	PGN EF00h	Proprietary-A (PDU1 peer-to-peer)
	Process data	PGN FFnnh	Proprietary-B (PDU2 broadcast); nn Group Extension (PS) configurable

<b>Specifications</b>	Excitation voltage	8 ... 36 V DC
	Excitation current	15/30 mA typical for 24/12 V, 100 mA max.
	Measuring rate	1 kHz standard
	Stability (temperature)	±100 x 10 <sup>-6</sup> / °C f.s.
	Repeatability	1 LSB
	Operating temperature	-40 ... +85 °C
	Protection	Reverse polarity, short circuit
	EMC	EN61326-1:2006

Signal wiring / connection	Signal name	Connector pin
	Shield	1
	Excitation +	2
	GND	3
	CAN-H	4
	CAN-L	5

View to sensor connector

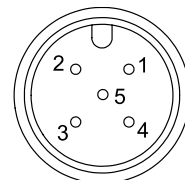

**POSITILT<sup>®</sup>**  
**PTAM/PTDM**  
**Characteristic of the linear output**



**Output signal**

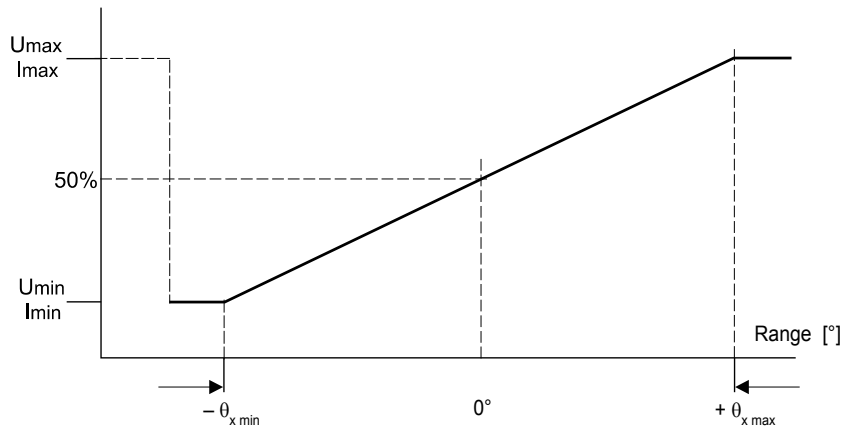

**PTAM5/PTDM5**

1 axis

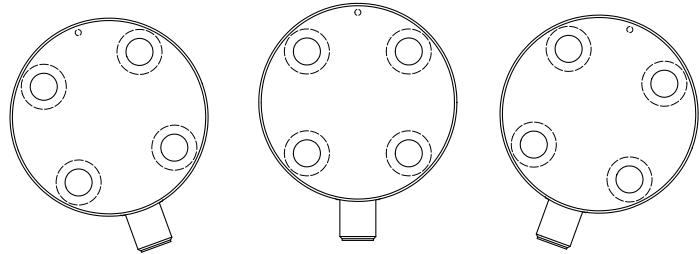

**PTAM5/PTDM5**

2 axes

**X**

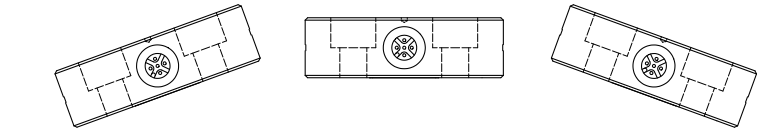

**Y**

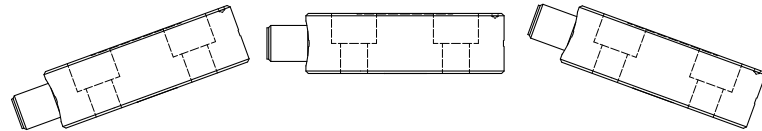

**PTAM27/PTDM27**

1 axis

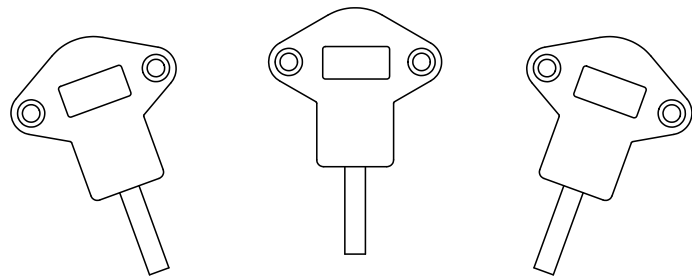

**PTAM27/PTDM27**

2 axes

**X**

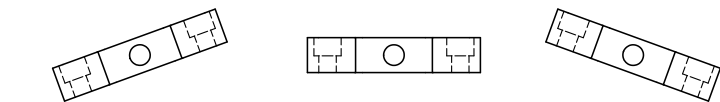

**Y**

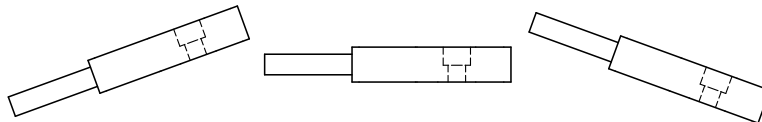



**Connector/bus cable  
for POSIROT®-  
POSITILT® sensors**  
5 pin M12  
CAN bus

The 5-lead shielded cable is supplied with a female 5-pin M12 connector at one end and a male 5-pin M12 connector at the other end. Available lengths are 2, 5 and 10 m.

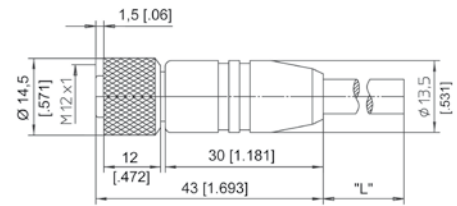

Order code:

**KAB - XM - M12/5F/G - M12/5M/G - CAN**

**IP69K: KAB - XM - M12/5F/G/69K - M12/5M/G/69K - CAN**

Length in m

**T-piece for bus cable**  
5 pin M12  
CAN bus

Order code:

**KAB - TCONN - M12/5M - 2M12/5F - CAN**



**Terminating  
resistance**  
5 pin M12  
CAN bus

Order code:

**KAB - RTERM - M12/5M/G - CAN**

