

Documenting Universal Calibrator DIGISTANT®

For thermal, electrical and mechanical values

Model 4423

Code:	4423 EN
Delivery:	ex stock
Warranty:	24 months

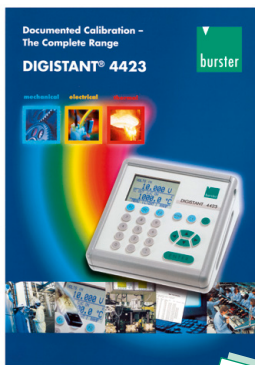

Ask for our
DIGISTANT® brochure.

4423 EN

- Basic accuracy 0.015 %
- Simultaneous sourcing / measurement for transmitter calibration
- Storage of calibration routines for 50 calibration objects (as found / as left)
- Plug & Measure connection for connectable sensors for mechanical values
- 24 VDC power supply for transmitter calibration
- Direct input of Pt100 coefficient (R0, A, B, C)
- Current sink
- User-friendly configuration and data recording software

Description

For the first time, the newly developed DIGISTANT® makes it possible to calibrate mechanical magnitudes such as force, torque or displacement using a single calibrator, in addition to the usual electrical and thermal magnitudes.

What makes this versatile calibrator stand out from its class is its capacity to generate the extensive and comprehensive documentation that is necessary nowadays for any calibration. The DigiCal software allows the calibration results to be downloaded from the DIGISTANT® for the purposes of documentation and logging. Up to 21 measurements per device for up to 50 devices can be stored in non-volatile memory. The tested items can also be classified as „good/bad“ according to the error tolerances permitted for the device. In addition, it is possible to group measurements together according to the initial check (as found) and after adjustment (as left).

Measurement and sourcing for 13 thermocouple models, 13 RTD models, resistance, current, voltage, frequency, pulse, pressure, force, torque and displacement make the model 4423 a complete universal calibrator. Arrow keys, the direct input of numerical values and 3 function keys for operators control, plus background illumination and menu operation through a large graphic display create a powerful, self-explanatory user interface. The DIGISTANT® model 4423 has a robust aluminum console housing. The built-in NiMH battery is protected against overcharging and deep discharge. The device can also operate in buffer mode using the mains adapter provided. The universal calibrator is supplied complete with its plug-in mains adapter, test certificate with traceability certification and measuring cable.



Connections

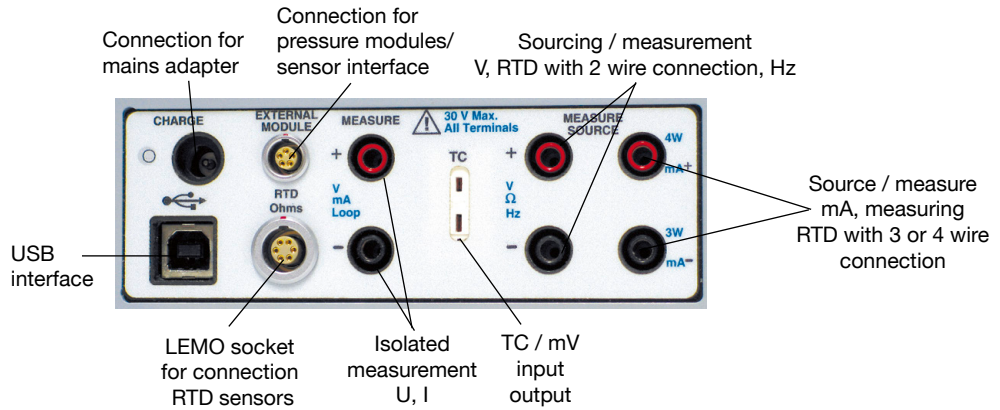

Operation

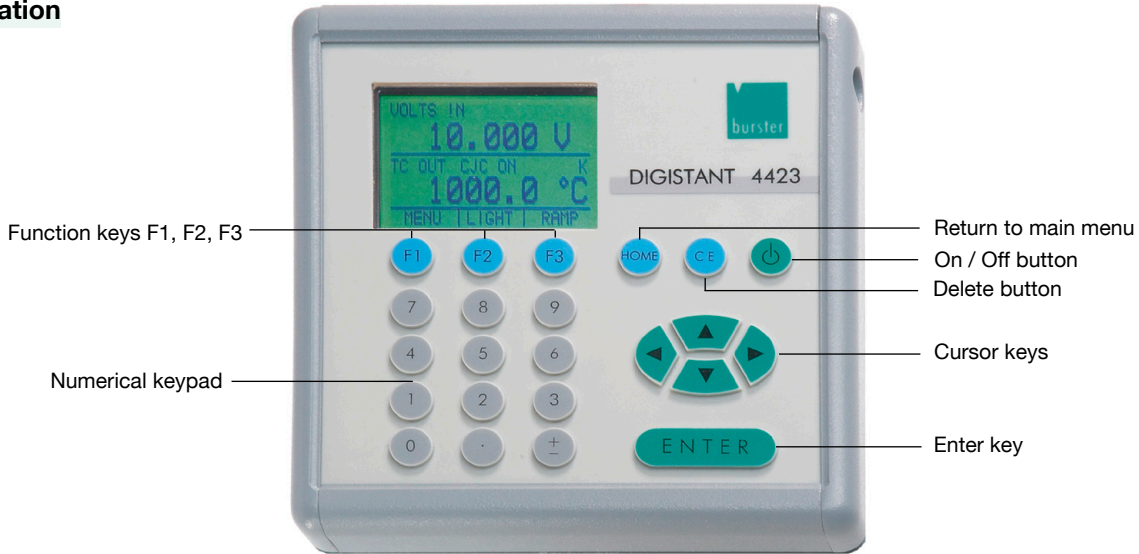

Display functions

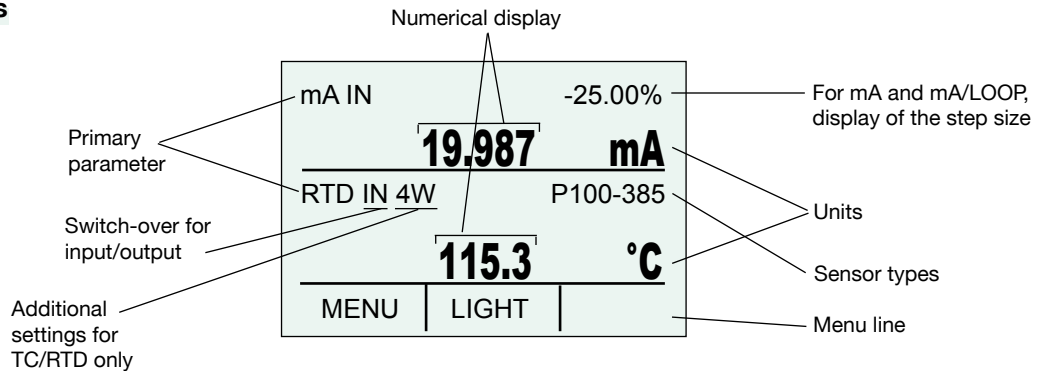

Temperature measurement and calibration accessories

External reference junction model 4485-V001 for thermocouples

- for precision measurement/simulation
- integrated Pt100 sensor for temperature measurement
- thermally stable, decoupled configuration
- connection: miniature thermocouples plug



Pt100 measurement sensor 42510

- standard laboratory sensor class A, 1/6 DIN at 0 °C
- temperature range - 50 °C ... 500 °C
- dimensions $\varnothing \times L$ 6 x 250 [mm]

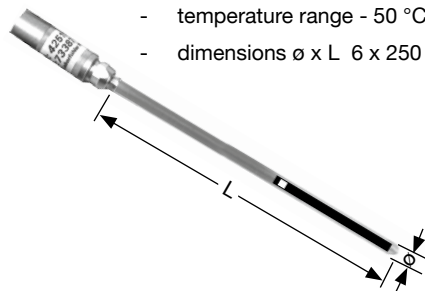

DIGISTANT® Model 4423

Typical applications

TC

Measurement and simulation of thermocouples:

Temperature simulation

13 of the most common models are available (see technical data)

Reference junction:

- | | |
|-------------------------------|---------------------|
| internal reference junction | - CJC ON |
| reference junction switch off | - CJC OFF |
| | the temperature is |
| | referenced to 0 °C |
| external reference junction | - CJC EXT |
| | automatic recording |
| | of the temperature |

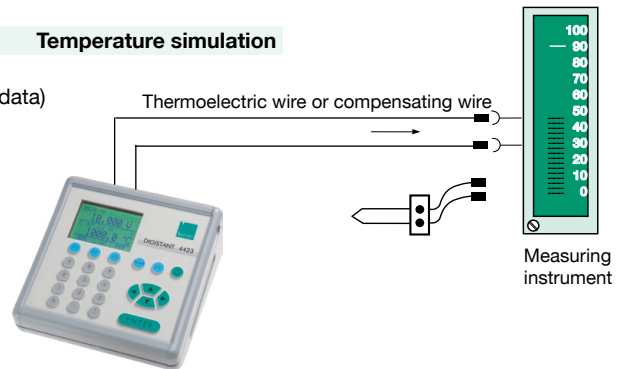

RTD

Simulation of resistance thermometers:

Pt100 simulation

Electronic simulator for Ni100, Pt100, Pt200, Pt500 and Pt1000. The temperature range for "simulation" extends from -200 °C to +800 °C. Any of the units °C, °F and Ω can be chosen.

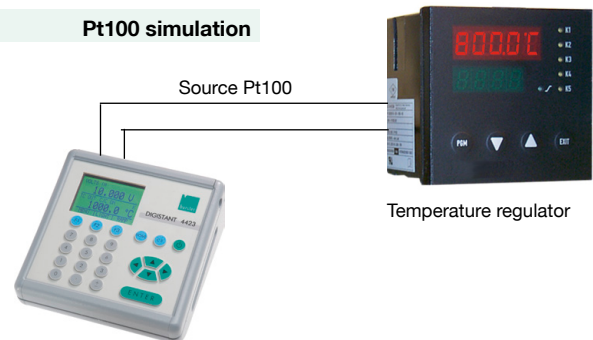

U/I

Simultaneous simulation and measurement of process magnitudes:

Process control

The DIGISTANT® model 4423 simulates a temperature sensor at the transmitter input. The voltage or current output signal is measured and indicated on the calibrator's display.

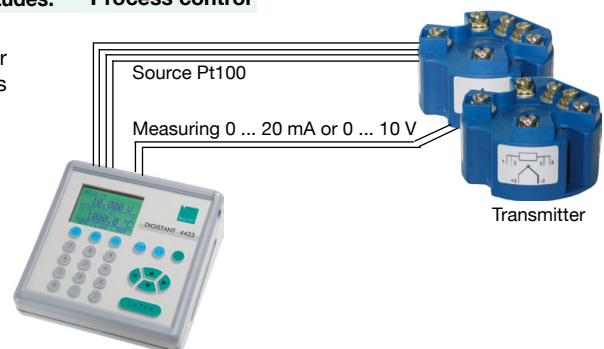

F

Force measurement:

Checking a load press

Force, torque and displacement sensors can be connected via the Smart Sensor Interface 7160. Data from the connected sensor are recognized via the "Plug and Measure" connection. DIGISTANT® model 4423, in conjunction with the interface and for instance, a force sensor, provides a universal reference measurement chain for calibrating press-insertion measurement chains. Very high precision is achieved with static measurements. The dynamic measurement function allows the recording of peak values.



P

Pressure measurement

Checking a pressure line

The series 7132 pressure model is connected to the 7130 pressure module adapter on the DIGISTANT® model 4423. The calibrator can display the pressure on the upper and lower lines. Select the desired pressure unit. Adjust the zero point. In this way a pressure line can quickly and economically be checked and calibrated with high precision for compliance with the necessary parameters.

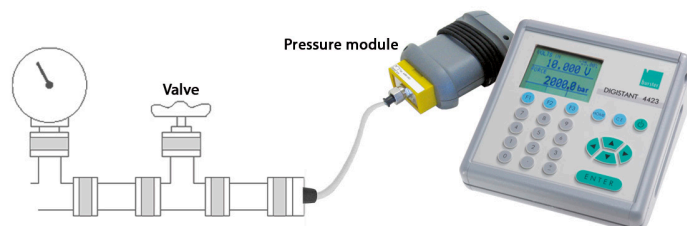

Document function

It is very easy to add documentation during the normal test procedure. Before you begin, choose "DOCUMENT" from the menu. Then select the input and output models, e.g. „source thermocouple“ and „measure voltage“. Manual input is a useful function. It is possible, for instance, to enter the measured voltage of a device manually without using an interface. This allows you to calibrate and document almost anything. After entering (tags) identifiers manufacturer, model, serial number, tester, ambient conditions and so forth, save the data. You have now completed the „as found“ part of your calibration. It is possible to adjust the measured values first if they are not within tolerance. If all data are within tolerance, you can save the so-called „as found /as left“ data, thereby documenting the complete data before and after your calibration.



It is possible to scroll through the „as left“ test points.

You can also specify that the calibrator will make a „good/bad“ decision on the basis of the device’s permitted error tolerance.

DigiCal Configuration and Data Acquisition Software

- Creating automatic calibration procedures
- Enter and send all document data to DIGISTANT® 4423
- Save measurement data in Excel
- Measurements can be displayed graphically or in table form
- Device settings and/or program procedures can be printed out
- Processing the saved data/history
- Printing out measurement logs
- Password protection for various levels
- Total control ability of DIGISTANT® 4423 over USB
- Calibration procedures are stored in the device

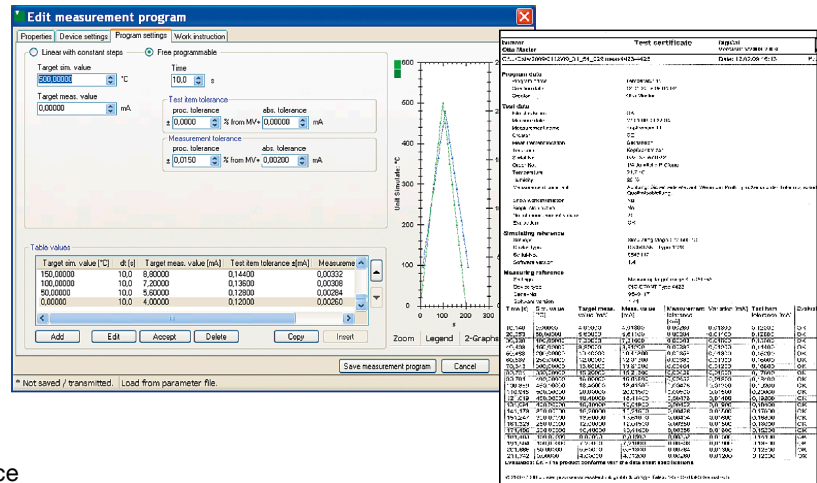

DIGISTANT® model 4423 and DigiCal for use in the field or in the laboratory

Industrial quality requirements specify that measuring instruments, regulators, transmitters and so forth used for process control are regularly recalibrated. This routine work is made much simpler by creating calibration procedures with the DigiCal PC software. They can then be used for calibration procedures in the field or in the laboratory.



Remote control

The DIGISTANT® model 4423 can be remotely controlled from a PC with a USB interface. Control can take place through the DigiCal software, or a user program can be linked in. A Win 32 and a Lab Windows/LabView driver are supplied with the device free of charge. The connection is made through a standard USB Type B connector. All interface commands are detailed in the manual.

Program description

Calibration and documentation present significant challenges to quality assurance. A software has been developed for the DIGISTANT® through which the calibrator can be fully controlled.

Documentation

- Simple entry of the needed data for test up to 50 devices
- 21 source and measurements values may be configured for each device under test
- Entry of general data as identifier, device, model etc...
- After calibration the documentation data may be printed or saved

General

- Generation of calibration procedures, helpful for the simultaneous measuring and source function
- Device settings can be saved to a file as backup, reloaded and edited
- Measurements can be saved as an Excel file or as raw data
- Measurement log can be printed
- 4423 can be fully parameterized via USB interface
- Security settings master and one or more user
- Only the master has full access
- Checkup of latest version through Internet
- The configuration software runs on the following operation system:

Windows XP
 Windows 2003 / 2008 / 2012
 Windows Vista
 Windows 7
 Windows 8 / 8.1

Technical Data for DIGISTANT® Model 4423

Electrical Data

Range	Resolution	Tolerance from Measured or Set Value
Voltage source		
-10.000 to +75.000 mV	0.001 mV	± 0.02 % ± 10 µV*
0.000 to 20.000 V DC	0.001 V	± 0.015 % ± 2 digits (max 3.5 mA)
Voltage measurement		
-10.000 to +75.000 mV	0.001 mV	± 0.02 % ± 10 µV*
not isolated -0.100 to +20.000 V DC	0.001 V	± 0.015 % ± 2 digits
isolated -0.100 to +30.000 V DC	0.001 V	± 0.015 % ± 2 digits
Current source		
0.000 to 24.000 mA / 1 kΩ to 20 mA	0.001 mA	± 0.015 % ± 2 digits
Current measurement (isolated/not isolated)		
- 0.100 ... 24.000 mA	0.001 mA	± 0.015 % ± 2 digits
Resistance simulation (work with all pulsed instrumentation transmitter ≥ 5 ms)		
5.0 to 400 Ω/lmeas 0.1 -0.5 mA	0.1 Ω	± 0.015 % ± 0.1 Ω
5.0 to 400 Ω/lmeas 0.5 -3.0 mA	0.1 Ω	± 0.015 % ± 0.03 Ω
400 to 1500 Ω/lmeas 0.05-0.8 mA	1 Ω	± 0.015 % ± 0.3 Ω
1500 to 4000 Ω/lmeas 0.05-0.4 mA	1 Ω	± 0.015 % ± 0.3 Ω
Resistance measurement		
0.00 to 400.00 Ω	0.01 Ω	± 0.015 % ± 0.03 Ω
400.1 to 4000.0 Ω	0.1 Ω	± 0.015 % ± 0.3 Ω

*Connected to thermocouple terminal

Frequency

Range	Tolerance
Frequency (Amplitude adjustable 1 ... 20 V) rectangular	
CPM source 2.0 to 600.0 CPM	± 0.05 %
Hz source 1.0 to 1000.0 Hz	± 0.05 %
kHz source 1.0 to 10.0 kHz	± 0.25 %
CPM measure 2.0 to 600.0 CPM	± 0.05 % ± 0.1 CPM
Hz measure 1.0 to 1000.0 Hz	± 0.05 % ± 0.1 Hz
kHz measure 1.00 to 10.0 kHz	± 0.05 % ± 0.01 kHz
Pulse (Amplitude adjustable 1 ... 20 V) source only	
Pulse 1 to 30.00	
2 CPM to 10.0 kHz	

Thermocouples models

Thermocouples	Range	Tolerance
Measure /Source		
J EN 60584-1/ITS90	-200.0 to 0.0 °C	0.4 °C
	0.0 to 800.0 °C	0.2 °C
	800.1 to 1200.0 °C	0.3 °C
K EN 60584-1/ITS90	-200.0 to 0.0 °C	0.6 °C
	0.0 to 1000.0 °C	0.3 °C
	1000.1 to 1372.0 °C	0.5 °C
T EN 60584-1/ITS90	-200.0 to 0.0 °C	0.6 °C
	0.0 to 400.0 °C	0.2 °C
E EN 60584-1/ITS90	-200.0 to -100.0 °C	0.2 °C
	-100.0 to 950.0 °C	0.2 °C
R EN 60584-1/ITS90	0 to 1750 °C	1.2 °C
S EN 60584-1/ITS90	0 to 1750 °C	1.2 °C
B EN 60584-1/ITS90	600 to 800 °C	1.2 °C
	801 to 1000 °C	1.3 °C
	1001 to 1820 °C	1.5 °C
C Hoskins E 988	0.0 to 1000.0 °C	0.6 °C
	1000.1 to 2316.0 °C	2.3 °C
XK GOST	-200.0 to 800.0 °C	0.2 °C
BP NIST	0.0 to 2500.0 °C	0.9 °C
L DIN 43710/IPTS68	-200.0 to 0.0 °C	0.25 °C
	0.0 to 900.0 °C	0.2 °C
U DIN 43710/IPTS68	-200.0 to 0.0 °C	0.5 °C
	0.0 to 400.0 °C	0.25 °C
N EN 60584-1/ITS90	-200.0 to 0.0 °C	0.8 °C
	0.0 to 1300.0 °C	0.4 °C

All tolerances are quoted without error at the reference junction. The reference junction error outside 23 °C ± 5 °C is 0.05 °C / °C. Additional reference junction error 0.2 °C.

Temperature measurement / temperature simulation RTD

Designation	Range	Tolerance from Measured or Set Value
Measure Source		
Ni120 (672) Minco	- 80.0 to 260.0 °C	± 0.08 °C ± 0.06 °C
Ni100 (618)		
DIN 43760/IPTS68	- 60.0 to 250.0 °C	± 0.08 °C ± 0.15 °C
CU10 (427)	- 100.0 to 260.0 °C	± 0.82 °C ± 0.82 °C
CU50 GOST	- 180.0 to 200.0 °C	± 0.18 °C ± 0.2 °C
CU100 GOST	- 180.0 to 200.0 °C	± 0.11 °C ± 0.13 °C
YSI400	15.0 to 50.0 °C	± 0.02 °C ± 0.05 °C
Pt100 (385)		
DIN EN 60751:1996	- 200.0 to 200.0 °C	± 0.13 °C -
	200.0 to 800.0 °C	± 0.23 °C -
	- 200.0 to 400.0 °C	- ± 0.2 °C
	400.0 to 800.0 °C	- ± 0.29 °C
Pt200 (385)		
DIN EN 60751:1996	- 200.0 to 100.0 °C	- ± 0.45 °C
	100.0 to 300.0 °C	- ± 0.52 °C
	300.0 to 630.0 °C	- ± 0.66 °C
	- 200.0 to 630.0 °C	± 0.61 °C -
Pt500 (385)		
DIN EN 60751:1996	- 200.0 to 100.0 °C	- ± 0.21 °C
	100.0 to 300.0 °C	- ± 0.26 °C
	300.0 to 630.0 °C	- ± 0.34 °C
	- 200.0 to 630.0 °C	± 0.31 °C -
Pt1000 (385)		
DIN EN 60751:1996	- 200.0 to 100.0 °C	- ± 0.14 °C
	100.0 to 300.0 °C	- ± 0.18 °C
	300.0 to 630.0 °C	- ± 0.25 °C
	- 200.0 to 630.0 °C	± 0.21 °C -
Pt10-385		
	- 200.0 to 100.0 °C	- ± 0.84 °C
	100.0 to 300.0 °C	- ± 0.95 °C
	300.0 to 630.0 °C	- ± 1.09 °C
	630.0 to 800.0 °C	- ± 1.2 °C
	- 200.0 to 800.0 °C	± 1.13 °C -
Pt50-385		
	- 200.0 to 100.0 °C	- ± 0.25 °C
	100.0 to 300.0 °C	- ± 0.26 °C
	300.0 to 630.0 °C	- ± 0.34 °C
	630.0 to 800.0 °C	- ± 0.4 °C
	- 200.0 to 800.0 °C	± 0.33 °C -
Pt100(3926) + Pt 100 (3916)		
	- 200.0 to 100.0 °C	- ± 0.13 °C
	100.0 to 300.0 °C	- ± 0.17 °C
	300.0 to 630.0 °C	- ± 0.25 °C
	- 200.0 to 200.0 °C	± 0.13 °C -
	200.0 to 630.0 °C	± 0.2 °C -

RTD: works with all pulsed instrumentation transducers up to ≥ 5 ms

The measuring precision is based on the use of 4 wire technology. If 3 wire technology is used, ± 0.05 Ω must be added. All values are applicable at 23 °C ± 5 °C. Outside this temperature range, the measurement is accurate to ± 50 ppm/K.

Operating temperature range: -10 °C to 50 °C

Storage temperature: -20 °C to 70 °C

Auxiliary supply:

- a) Ni-MH accu built-in battery, operating time > 16 h (10 mA into 1 kΩ)
- b) 230 VAC mains adapter, mains-buffered operation is possible

Interface: USB

Housing: Aluminium console with plastic side pieces

Dimensions: (W x H x D): 160 x 85 x 175 mm

Weight: approx. 1 kg

Protection class IP 50

Protection category III

Order Code

Order Code Device

Universal calibrator DIGISTANT® model 4423 including mains adapter, test certificate with proof of traceability, USB cable and one pair of measuring cables, model 4490 **Model 4423**

DigiCal PC software for DIGISTANT® model 4423 **Model 4423-P001**

Temperature accessories

Reference junction suitable to DIGISTANT®4423 **Model 4485-V001**

Measuring cable for resistance and Pt100 measurements length 1 m, with banana plugs (4 wire measurement), LEMO connector (6 pin, 1B) **Model 4499**

One pair of measuring cables, length 1 m, with two banana plugs, two probes and two test clamps (included in delivery) **Model 4490**

Connector for Pt100 input **Model 4291-0**

Miniature connector model K **Model 4415-Z003**

Pt100 measuring sensor **Model 42510**

Connecting line for laboratory sensor model 42510, length 2 m **Model 4281-0**

Measurement cable for mV simulation/measure **Model 99108-415A-0030015**

Pressure accessories

Interface adapter **Model 7130**

Pneumatic manual pump -850 mbar ... 7 bar **Models 7106-V0007**

Pressure manual pump -960 mbar ... 34 bar **Models 7106-V0034**

Hydraulic manual pump 0 bar ... 690 bar **Models 7106-V0690**

Adapter kit
2 x 1/4" NPT female, 2 x 1/8" NPT male,
2 x 1/8" tube connector, T fitting 1/8"
NPT female, T fitting 1/8 tube connector **Models 7132-Z002**

Pressure modules

Range	Accuracy (F.S.)	Overload	Model
Against atmospheric pressure			
0 to 20 mbar	± 0.1 %	400 %	7132-4020
0 to 67 mbar	± 0.05 %	400 %	7132-4067
0 to 350 mbar	± 0.025 %, 0.207 mbar	400 %	7132-4350
0 to 500 mbar	± 0.035 %, 0.172 mbar	300 %	7132-4500
0 to 700 mbar	± 0.025 %, 0.172 mbar	300 %	7132-4700
0 to 1 bar	± 0.025 %, 0.172 mbar	300 %	7132-5001
0 to 2 bar	± 0.025 %	300 %	7132-5002
0 to 3.5 bar	± 0.03 %	300 %	7132-50035
0 to 7 bar	± 0.025 %	300 %	7132-5007
0 to 10 bar	± 0.035 %	200 %	7132-5010
0 to 20 bar	± 0.025 %	200 %	7132-5020
0 to 34 bar	± 0.025 %	200 %	7132-5034
0 to 70 bar	± 0.025 %	200 %	7132-5070
0 to 100 bar	± 0.035 %	200 %	7132-5100
0 to 200 bar	± 0.1 %	200 %	7132-5200
0 to 340 bar	± 0.1 %	200 %	7132-5340
0 to 700 bar	± 0.1 %	150 %	7132-5700
Vacuum			
0 to -350 mbar	± 0.025 %, 0.207 mbar	400 %	7132-4350- V001
0 to -1 bar	± 0.025 %, 0.172 mbar	300 %	7132-5001- V001
Absolute			
0 to 1 bar	± 0.025 %, 0.172 mbar	300 %	7132-5001- V002
0 to 2 bar	± 0.025 %	300 %	7132-5002- V002
0 to 3.5 bar	± 0.03 %	300 %	7132-50035- V002
0 to 7 bar	± 0.025 %	300 %	7132-5007- V002
0 to 20 bar	± 0.025 %	200 %	7132-5020- V002
Dual pressure / compound			
-1 to 1 bar	± 0.025 %, 0.172 mbar	300 %	7132-5001- V003
-1 to 2 bar	± 0.025 %, 0.172 mbar	300 %	7132-5002- V003
Difference			
0 to 350 mbar	± 0.025 %, 0.207 mbar	400 %	7132-4350- V004
0 to 2 bar	± 0.025 %	300 %	7132-5002- V004
0 to 3.5 bar	± 0.03 %	300 %	7132-50035- V004

For further, comprehensive information, please see data sheet 7132 in product group 7.

Accessories for measuring force, torque, displacement

Adapter for Smart Sensor Interface model 7160 and Pressure Modules series 7132 to DIGISTANT® model 4423 **Model 7130**

Adapter for Smart Sensor Interface model 7160 and Pressure Modules series 7132 direct to PC via USB interface **Model 7131-USB**

1 Smart Sensor Interface for connecting force, displacement and torque sensors **Model 7160**

For further, comprehensive information, please see data sheet 7160 in product group 7.

Compatible sensors for force, torque and displacement can be found in the Sensors and Process Instruments catalog.

Other Accessories

Ever-ready case made of artificial leather for model 4423 with strap **Model 4493-V004**

Aluminium case for Universal Calibrator model 4423 **Model 4493-V002**

Mains adapter (included with instrument) **Model 4495-V001**

One pair of banana plugs with clamped connection **Model 4498**

USB interface cable 1.5 m ST(A) - ST(B) **Model 9900-K349**

Calibration Certificate for DIGISTANT® Model 4423

DAkKS calibration or factory calibration

Standard calibration certificate with 193 DC calibration points:

- every 7 measurement points for each voltage measurement and sourcing range
- every 9 measurement points for each thermocouple measurement and sourcing range function "mV"
- every 8 measurement points for each current measurement and sourcing range
- every 6 measurement points for each resistance measurement and sourcing range
- 56 measurement points each for thermocouple models in the „measure“ and „source“ operating modes, reference junction temperature 0 °C, measurements in mV and calculated values in °C
- 60 measurement points for Pt10, Pt50, Pt100, Pt200, Pt500, Pt1000, Ni100

Model 44DKD-4423 / Model 44WKS-4423

DAkKS Calibration Certificate

DAkKS Calibration Certificate for force to 200 kN, pressure to 5000 bar and torque to 5 kNm

Manufacturer Calibration Certificate

Manufacturer Calibration Certificate for force to 200 kN, pressure to 5000 bar, torque to 5 kNm and displacement to 300 mm

You are also very welcome, in addition to the data sheet, to request our color brochure about DIGISTANT® model 4423 "Documented calibration - the complete range".

